

Constant climate chamber HPP1400

Our constant climate chamber is tailored to environmental simulation, material testing and stability testing in accordance with the ICH guidelines.

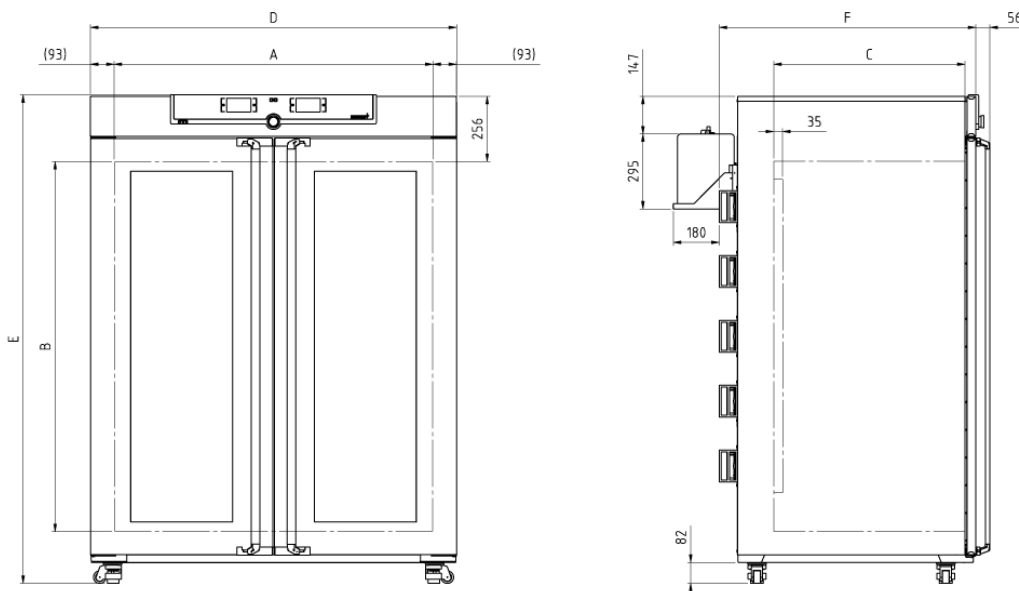

On this page, you can find all the essential technical data on the Memmert stability chamber HPP. Our customer relations team will be pleased to help if you want further information. If you should require a customised special solution, please contact our technical specialists at sales@memmert.com.



Temperature

Setting temperature range	without light, with humidity: +15 to +60 °C
Setting temperature range	without light, without humidity: +15 to +60 °C
Working temperature range	without light, with humidity: +15 (at least 10 below ambient temperature) to +60 °C
Working temperature range	without light, without humidity: 15 (at least 10 below ambient temperature) to +60 °C
Setting accuracy temperature	0.1 °C
Temperature sensor	2 Pt100 sensors DIN Class A in 4-wire-circuit for mutual monitoring, taking over functions in case of an error

Humidity

Setting range humidity	10 - 80 % rh
Humidity	humidity supply with distilled water from external tank by self-priming pump
Humidification	humidification by hot steam generator
Dehumidification	dehumidification by cold trap using the Peltier technology
Setting accuracy humidity	0.5 % rh

Control technology

ControlCOCKPIT	TwinDISPLAY. Adaptive multifunctional digital PID-microprocessor controller with 2 high-definition TFT-colour displays.
Language setting	German, English, Spanish, French, Polish, Czech, Hungarian
adjustable parameters	temperature (Celsius or Fahrenheit), relative humidity, programme time, time zones, summertime/wintertime
Timer	Digital backwards counter with target time setting, adjustable from 1 minute to 99 days
Function HeatBALANCE	adapting the distribution of the heating performance of the upper and lower heating circuit from -50 % to +50 %
Function SetpointWAIT	the process time does not start until the set temperature is reached
Calibration	three freely selectable values each, temperature and humidity

Communication

Interface	Ethernet LAN, USB
Documentation	programme stored in case of power failure
Programming	AtmoCONTROL software on a USB stick for programming, managing and transferring programmes via Ethernet interface or USB port

Safety

Temperature control	over- and undertemperature monitor TWW, protection class 3.3 or adjustable temperature limiter TWB, protection class 2, selectable on display
AutoSAFETY	additionally integrated over- and undertemperature protection "ASF", automatically following the setpoint value at a preset tolerance range, alarm in case of over- or undertemperature, heating function is switched off in case of overtemperature, cooling function in case of undertemperature
Autodiagnostic system	integral fault diagnostics for temperature and humidity control
Alarm	visual and acoustic

Heating concept

Peltier	energy-saving Peltier heating-/cooling system integrated in the rear (heat pump principle)
----------------	--

Standard equipment

Works calibration certificate	for +25 °C/40 % rh and +40 °C/75 % rh
Door	Stainless steel doors with glass sectors, fully heated inner glass panes integrated in the full-sight glass door with 2-point locking (compression door lock)
Internals	4 stainless steel grid(s), electropolished
Standard accessories	Water tank including connection hose

Stainless steel interior

Dimensions	$w_{(A)} \times h_{(B)} \times d_{(C)}$: 1250 x 1450 x 750 mm (d less 10 mm for fan - Peltier)
Volume	1360 l
Max. number of internals	28
Max. loading of chamber	250 kg
Max. loading per internal	30 kg

Textured stainless steel casing

Dimensions	$w_{(D)} \times h_{(E)} \times d_{(F)}$: 1435 x 1913 x 1007 mm (d +56mm door handle)
Installation	on lockable castors, adjustable in height
Housing	rear zinc-plated steel

Electrical data

Voltage	230 V, 50/60 Hz
Electrical load	approx. 3100 W

Ambient conditions

Set Up

The distance between the wall and the rear of the appliance must be at least 15 cm. The clearance from the ceiling must not be less than 20 cm and the side clearance from walls or nearby appliances must not be less than 5 cm.

Ambient temperature	16 °C to 40 °C
Humidity rh	max. 70 %, non-condensing
Altitude of installation	max. 2,000 m above sea level
Overvoltage category	II
Pollution degree	2

Packing/shipping data

Transport information	The appliances must be transported upright
Customs tariff number	8419 8998
Country of origin	Federal Republic of Germany
WEEE-Reg.-No.	DE 66812464
Dimensions approx incl. wooden box	w x h x d: 1560 x 2200 x 1190 mm
Net weight	approx. 450 kg
Gross weight wooden box	approx. 639 kg

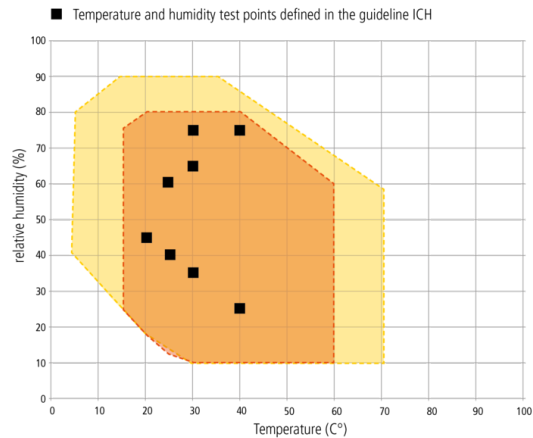

Temperature-humidity working range HPP
 ● HPP110 - HPP1060 without light/ ● HPP1400 & HPP2200

Standard units are safety-approved and bear the test marks

